



FASTENERS



WE-LOCK Co.

AN ISO 9001 : 2008 / ISO 14001 / ISO 18001 CERTIFIED COMPANY



WE-LOCK Co.

AN ISO 9001 : 2008 / ISO 14001 / ISO 18001 CERTIFIED COMPANY

HEXAGONAL NUT

Hexagon Nuts are Designed to perfection, these nuts possess close tolerance and precision dimensions. Our quality controllers undertake stringent quality measures in order to provide our clients a flawless range of nuts. Further, to retain the trust of our valued clients, we also provide them with certificate regarding testing parameters undertaken by our organization. We offer our range of Hexagon Nuts in various sizes, thicknesses & dimensions, and material & grades. These nuts meet the requirements of hardware, engineering, electrical and various other industries. We also customize our range of Hexagonal Nuts to meet the different requirements of our clients. Further, our range can be availed at market leading prices.

Stainless Steels Material Grade : 304, 304B, 309, 310, 316, 316B, 317, 317L, 321, 347, 401, 416, 430 & 501.

Diameter : M27 to M52

Duplex & Super Duplex : UNS31803, S32750.

Diameter : M16 to M27

Hastelloy : Hastelloy C-276, Hastelloy C-22.

Diameter : M8 to M27

Exotics : 904L, A-286, Alloy20, Alloy50, NitronicAlloys50, Titanium.

Diameter : M8 to M27

Nickel Alloys : Inconel 600, 601, 625, 718, 750, 800/800H, 825, 925, Monel 400, 405, K-500 & Nickel 200.

Diameter : M8 to M27

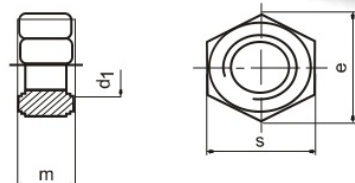

" All measurements in millimeters (mm)"

DIN 934 / ISO 4032

THREADED RODS: DIN 975 & DIN 976

Stainless Steels Material Grade : 304, 304B, 309, 310, 316, 316B, 317, 317L, 321, 347, 401, 416, 430 & 501.

Diameter : M3 to M100 From 10MM to 6MTS

Duplex & Super Duplex: UNS31803, S32750.

Diameter : M3 to M100 From 10MM to 1000MM

Hastelloy : Hastelloy C-276, Hastelloy C-22.

Diameter : M3 to M36 From 10MM to 1000MM

Exotics : 904L, A-286, Alloy20, Alloy50, NitronicAlloys50, Titanium.

Diameter : M3 to M36 From 10MM to 1000MM

Nickel Alloys : Inconel 600, 601, 625, 718, 750, 800/800H, 825, 925, Monel 400, 405, K-500 & Nickel 200.

Diameter : M3 to M36 From 10MM to 1000MM

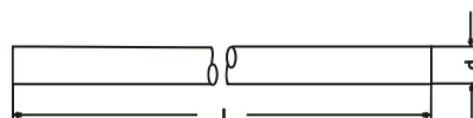



WE-LOCK Co.

AN ISO 9001 : 2008 / ISO 14001 / ISO 18001 CERTIFIED COMPANY

REFRACTORY ANCHOR

SS Refractory Anchors are manufactured from good grades of steel and have find applications in various industries. Some of the industries are cement, ceramic, steel, thermal, petrochemical, power and many more. The Stainless Steel Refractory Anchors offered by us are available in assortment of shapes and sizes but usually they are in the shape of Y, U and V. In addition to this, we provide availability of Refractory Anchors in unlike specifications as per the preferences of global clients. We are tagged as one of the most illustrious Industrial Refractory Anchors Suppliers from India. To enquire about the desired product(s)

Chemical Composition of Stainless Steel

Chemical Composition Per Cent/ Grade	C % Max	Mn % Max	P % Max	S % Max	Si % Max	Cr % Ni% Max	Nr% Max
304 304-L	0.08 0.03	2.00	0.045	0.030	1.00 0.75	18.00 to 20.00	08.00 to 10.00
310 310S	0.25 0.08	2.00	0.045	0.030	1.00 0.75	24.00 to 26.00	19.00 to 22.00

Temperature Resistant of Anchor Metal

Anchor Metal	Temperature Resistant
Mild Steel [MS]	540 Degree C
Stainless Steel 304	1080 Degree C
Stainless Steel 310	1350 Degree C

SPIRAL-Y-ANCHORS

We are specialized in manufacturing superior quality Spiral Y- Anchors,these are widely used in various industrial applications.

Specifications

- 215 X 145 X 5 MM.
- 190 X 45 X 5 MM.
- 185 X 105 X 5 MM.
- 175 X 30 X 5 MM.
- 155 X 70 X 5 MM.
- 90 X 30 X 5 MM.
- 80 X 30 X 5 MM.



U-ANCHORS

We manufacture and export superior quality U-Anchors, these can be availed in various specifications like:

- 55 X 16 X 05 MM.
- 225 X 27 X 05 MM.
- Wing Nut Type



V-ANCHORS

We are manufacturer & supplier of V-Anchor, to match all types of lining for cement, ceramic, steel, petrochemical, refinery industry for the retaining of monolithic, ceramic fiber and brick linings. Our anchors are suitable for single & dual layer lining, brick, ceramic, fiber and monolithic. All refractory anchor made from stainless steel [SS] 304, 310, Alloy 601- inconel and other heat resistant alloys.

Specifications: 55 X 15 X 05 MM



Y-ANCHORS AND CROOK ANCHORS

We manufacture a comprehensive range of refractory anchors for the cement, steel and petrochemical industry - for the retaining of castable and brick linings.Y Anchors and Crook Anchors are offered for immediate dispatch. Various C Clips and Hangers for ceramic anchors to suit individual requirements.

Specifications

- 230 X 115 X 05 MM.
- 200 X 100 X 05 MM.
- 150 X 75 X 05 MM.
- 75 X 25 X 05 MM.





WE-LOCK Co

AN ISO 9001 : 2008 / ISO 14001 / ISO 18001 CERTIFIED COMPANY

U-BOLTS STANDARD

We are able to provide any extensive range of U-Bolts. The precision engineered range of U-Bolts offered by us is at par with international quality standards and these are available in various grades, sizes, thicknesses, and dimensions as per the industry related application. Besides, we also offer these U-Bolts with extra long nuts and in full round, half round and square profiles on client's request.

Stainless Steels Material Grade : 304, 304B, 309, 310, 316, 316B, 317, 317L, 321, 347, 401, 416, 430 & 501.

Diameter : M6 to M36

Duplex & Super Duplex: UNS31803, S32750.

Diameter : M6 to M36

Hastelloy : Hastelloy C-276, Hastelloy C-22.

Diameter : M6 to M20

Exotics : 904L, A-286, Alloy20, Alloy50, NitronicAlloys50, Titanium.

Diameter : M6 to M20

Nickel Alloys : Inconel600, 601, 625, 718, 750, 800/800H, 825, 925, Monel 400, 405, K-500 & Nickel 200.

Diameter: M6 to M20

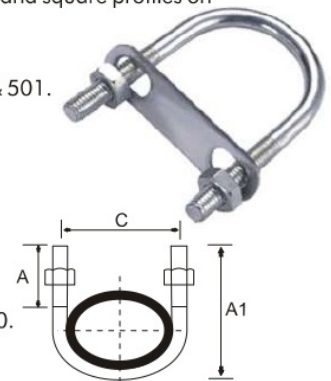

Features :

- Accurate dimension
- Corrosion resistance
- High efficiency
- High tensile strength Durability

Application Area :

- Pipe clamping
- Foundation support
- Installations and automotive support systems

RESIN ANCHOR BOLTS

Resin Anchor Bolt Assemblies are used both in new structure as well as replacement uses in old berths.

They are encapsulated in very high strength Epoxy Mortar, which, after inserting pre-packed bolt assembly in to the cavity prepared in jetty and pushing it with little force, breaks the resin capsule and allows to mix the part-a Resin with part-b Hardener to form solid bond between the bolt and concrete.

One Resin Anchor Bolt Assembly contains one no. Fender Fixing Stud, one no. Nut, one no. Chemical Resin Capsule and one no. loose Washer as per Fender type. Resin Anchor Assemblies are available in Stainless Steel as per requirement

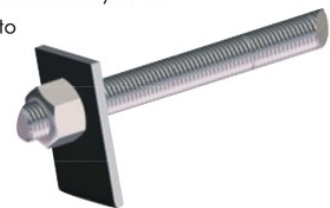

DOUBLE END STUD BOLTS

Stainless Steels Material Grade : 304, 304B, 309, 310, 316, 316B, 317, 317L, 321, 347, 401, 416, 430 & 501.

Diameter : M16 to M30 up to 1000 MM in Length

Duplex & Super Duplex : UNS31803, S32750.

Diameter : M16 to M30 up to 1000 MM in Length

Hastelloy : Hastelloy C-276, Hastelloy C-22.

Diameter: M16 to M30 up to 1000 MM in Length

Exotics : 904L, A-286, Alloy20, Alloy50, NitronicAlloys50, Titanium.

Diameter : M16 to M30 up to 1000 MM in Length

Nickel Alloys : Inconel600, 601, 625, 718, 750, 800/800H, 825, 925, Monel 400, 405, K-500 & Nickel 200.

Diameter : M16 to M30 up to 1000 MM in Length





WE-LOCK CO.

AN ISO 9001 : 2008 / ISO 14001 / ISO 18001 CERTIFIED COMPANY

Hex Bolts & Hex Screws DIN 931 / ISO4014 & DIN 933 / ISO4017

Our range of hex bolts & hex screws is widely used for high-end industrial purpose and automobile industry. These are acknowledged for wear & tear resistance, cost effectiveness, and long functional life. The Hex Head Bolts offered by us are at par with international quality standards. These are available in various shapes and sizes, and other customized forms as per client's specifications and details. We offer these bolts in various grades to suit the application area at industry leading prices.

Stainless Steels Material Grade : 304, 304B, 309, 310, 316, 316B, 317, 317L, 321, 347, 401, 416, 430 & 501 .

Diameter : M27 to M52 up to 500 MM in Length

Duplex & Super Duplex : UNS31803,S32750.

Diameter : M16 to M42 up to 300 MM in Length

Hastelloy : Hastelloy C-276, Hastelloy C-22.

Diameter : M8 to M27 up to 300 MM in Length

Exotics : 904L, A-286, Alloy20, Alloy50, NitronicAlloys50, Titanium.

Diameter : M8 to M27 up to 300 MM in Length

Nickel Alloys : Inconel600,601,625,718,750,800/800H,825,925,

Monel 400,405,K-500 & Nickel 200.

Diameter : M8 to M27 up to 300 MM in Length

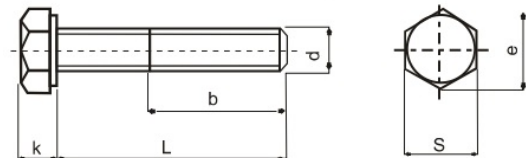

"b" measurement varies according to length of bolt

" All measurements in millimeters (mm)"

DIN 931 / ISO 4014

DIMENSIONS OF HEX HEAD BOLTS / SCREWS

Bolt Diameter (d1)	Thread Length over Full Length of Bolt			Head Height (k)	Across Corner (e)	Across Flat (s)
	(b to 125)	(b to 200)	(b Over 200)			
M4	14	-	-	2.8	7.66	7
M5	16	-	-	3.5	8.79	8
M6	18	24	-	4	11.05	10
M8	22	28	-	5.3	14.38	13
M10	26	32	46	6.4	18.9	17
M12	30	36	49	7.5	21.1	19
M14	34	40	53	8.8	24.49	22
M16	38	44	57	10	26.75	24
M18	42	48	61	11.5	30.14	27
M20	46	52	66	12.5	33.53	30
M22	50	56	69	14	35.72	35
M24	54	60	73	15	39.98	36
M27	60	66	79	17	45.2	41
M30	66	72	86	18.7	50.85	46
M33	72	78	91	21	55.37	50
M36	78	84	97	22.5	60.79	55
M42	90	96	109	26	71.3	65
M45	96	102	115	28	76.95	70
M48	102	108	121	30	82.60	75



WE-LOCK Co.

AN ISO 9001 : 2008 / ISO 14001 / ISO 18001 CERTIFIED COMPANY

PLAIN WASHERS

We manufacture our range of Plain Washers in different size options, dimensions, and finishes to suit different industrial applications. These are in high demands in the competitive market owing to their dimensional accuracy, high tensile strength, abrasion resistance, flawless finish, and durability. Our range of Plain Washer is quality tested on well defined parameters by our team of quality controllers. We also manufacture different types of washers as well i.e Tab Washers, Heavy Duty Washers, Tooth Washers, etc. To satisfy our clients fully, we also provide them with testing certificate. Our plain washers are also available in customized forms and at market competitive price.

Stainless Steels Material Grade : 304, 304B, 309, 310, 316, 316B, 317, 317L, 321, 347, 401, 416, 430 & 502

Diameter : M6 to M72

Duplex & Super Duplex : UNS31803,S32750.

Diameter : M6 to M72

Hastelloy : Hastelloy C-276, Hastelloy C-22.

Diameter : M6 to M72

Exotics : 904L, A-286, Alloy20, Alloy50, NitronicAlloys50, Titanium.

Diameter : M6 to M72

Nickel Alloys : Inconel600, 601, 625, 718, 750, 800/800H, 825,

925, Monel 400, 405, K-500 & Nickel 200.

Diameter : M6 to M72

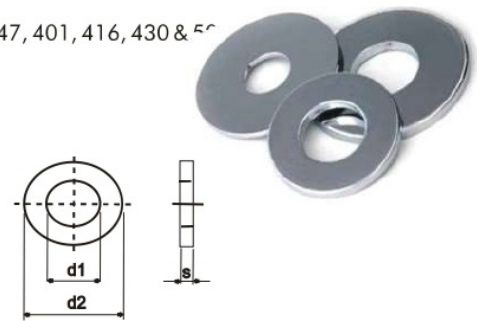

" All measurements in millimeters (mm)"

DIN 125 / DIN 7089

Dimensions of Plain Washers / Spring Washers

Inner Diameter (d1)	For Thread Size	Outer Diameter	Washer Thickness
1.7	M1.6	4	0.3
2.2	M2	5	0.3
2.7	M2.5	6	0.5
3.2	M3	7	0.5
3.7	M1.5	8	0.5
4.3	M4	9	0.8
5.3	M5	10	1
6.4	M6	12	1.6
7.4	M7	14	1.6
8.4	M8	16	1.6
10.5	M10	20	2
13	M12	24	2.5
15	M14	28	2.5
17	M16	30	3
19	M18	34	3
21	M20	37	3
23	M22	39	3
25	M24	44	4
28	M27	50	4
31	M30	56	4
34	M33	60	5
37	M36	66	5
40	M39	72	6
43	M42	78	7
50	M48	92	8
54	M52	98	8



WE-LOCK Co

AN ISO 9001 : 2008 / ISO 14001 / ISO 18001 CERTIFIED COMPANY

DEVELOPING TOMORROWS TODAY

HEXAGON THIN NUTS

We manufacture a comprehensive range of Hexagon Thin Nut. These nuts are fabricated using high-grade stainless steel, nickel alloy, and other useful material in compliance with international quality standards. The Hexagonal Thin Nuts offered by us are appreciated for stiffness, hardness, Rust proof, durability, and ability to withstand harsh weather conditions. Nuts are available in various sizes, lengths, thicknesses, dimensions and grades, which can be further custom made as required by our clients.

Stainless Steels Material Grade : 304, 304B, 309, 310, 316, 316B, 317, 317L, 321, 347, 401, 416, 430 & 501.

Diameter : M27 to M52

Duplex & Super Duplex : UNS31803,S32750.

Diameter : M16 to M100

Hastelloy : Hastelloy C-276, Hastelloy C-22.

Diameter : M8 to M36

Exotics : 904L, A-286, Alloy20, Alloy50, NitronicAlloys50, Titanium.

Diameter: M8 to M36

Nickel Alloys: Inconel600,601,625,718,750,800/800H,825,925,

Monel 400,405,K-500 & Nickel 200.

Diameter: M8 to M36



" All measurements in millimeters (mm)"

DIN 439 / ISO 4035

DIMENSIONS OF HEX HEAD NUTS

Size (d1)	Across Flat (s)	Across Corner (e)	Height (m)
M1	2.5	2.72	0.8
M1.2	3	3.29	1
M1.4	3	3.29	1.2
M1.6	3.2	3.48	1.3
M1.7	3.5	3.82	1.4
M2	4	4.32	1.6
M2.3	4.5	4.95	1.8
M2.5	5	5.45	2
M2.6	5	5.51	2
M3	5.5	6.01	2.4
M3.5	6	6.01	2.8
M4	7	7.66	3.2
M5	8	8.76	4
M6	10	11.05	5
M7	11	12.12	5.5
M8	13	14.38	6.5
M10	17	18.9	8
M12	19	21.1	10
M14	22	24.49	11
M16	24	26.75	13
M18	27	29.56	15
M20	30	32.95	16
M22	32	35.03	18

Size (d1)	Across Flat (s)	Across Corner (e)	Height (m)
M2436	39.55	19	
M27	41	45.2	22
M30	46	50.85	24
M33	50	55.37	26
M36	55	60.79	29
M39	60	66.44	31
M42	65	71.3	34
M45	70	76.95	36
M48	75	82.6	38
M52	80	88.25	42
M56	85	95.07	45
M60	90	100.72	48
M64	95	106.37	51
M68	100	112.02	54
M72	105	117.67	58
M76	110	123.32	61
M80	115	128.97	64
M85	120	133.11	68
M90	130	145.77	72
M95	135	151.42	76
M100	145	162.72	80



WE-LOCK Co

AN ISO 9001 : 2008 / ISO 14001 / ISO 18001 CERTIFIED COMPANY

Wedge Bolts

Wedge Bolts are generally employed to fix the Fender to a new wharfs or jetties to be constructed. One Anchor Bolt Assembly contains one no. Fender Fixing Bolt, one no. cast in Sleeve with back side extension Rod welded with end Flange and front side Flange and one no. loose Washer as per Fender type. The sleeves are cast integrally with the structure to ensure maximum strength, these sleeve can be supplied in Stainless Steel as per requirement.

They are very simple in design and user friendly. They are fixed with centering planks before casting of Fender Block, as per centre distances / template. If required we may also supply Anchor Bolts duly fixed in template as per center distance.



Resin Anchor Bolts

Resin Anchor Bolt Assemblies are used both in new structure as well as replacement uses in old berths. They are encapsulated in very high strength Epoxy Mortar, which, after inserting pre-packed bolt assembly in to the cavity prepared in jetty and pushing it with little force, breaks the resin capsule and allows to mix the part-a Resin with part-b Hardener to form solid bond between the bolt and concrete. One Resin Anchor Bolt Assembly contains one no. Fender Fixing Stud, one no. Nut, one no. Chemical Resin Capsule and one no. loose Washer as per Fender type. Resin Anchor Assemblies are available in Stainless Steel as per requirement



Finder to Frame Fixing Bolts

Stainless Steels Material Grade : 304 & 316





WE-LOCK CO.

AN ISO 9001 : 2008 / ISO 14001 / ISO 18001 CERTIFIED COMPANY

DOCK ACCESSORIES

U-Hooks

U Hooks are available both in MS and SS in different grades. These hooks are required for fixing of Chains for Fenders / Fendering Systems in New Wharf / Jetty or Structures.

U Hooks are available from 12 mm Diameter to 100 mm Diameter as per requirement. These Hooks can also be used as an anchor for Mooring Rings.



Anchor Bolts

Anchor Bolt Assemblies are generally employed to fix the Fender to a new wharfs or jetties to be constructed. One Anchor Bolt Assembly contains one no. Fender Fixing Bolt, one no. cast in Sleeve with back side extension Rod welded with end Flange and front side Flange and one no. loose Washer as per Fender type. The sleeves are cast integrally with the structure to ensure maximum strength, these sleeve can be supplied in Stainless Steel as per requirement.

They are very simple in design and user friendly. They are fixed with centering planks before casting of Fender Block, as per centre distances / template. If required we may also supply Anchor Bolts duly fixed in template as per center distance.

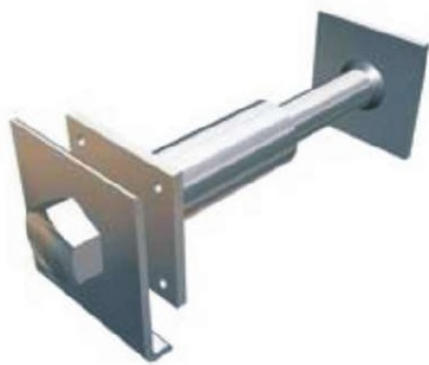



WE-LOCK CO.

AN ISO 9001 : 2008 / ISO 14001 / ISO 18001 CERTIFIED COMPANY

Product Range

Product Range



MATERIAL GRADES

EXOTIC ALLOYS

904L, A-286, Alloy20, Alloy 50, Nitronic Alloy 50, Titanium

HASTELLOY

Hastelloy C-276, Hastelloy C-22

NICKEL ALLOYS

Inconel 600, Inconel 601, Inconel 625, Inconel 718, Inconel 800/800H, Inconel 825, Inconel 925, Inconel 750, Monel 400, Monel 405, Monel K-500, Nickel

PH GRADES

13-8PH, 17-4 PH, 17-7 PH, 15-5 PH

DUPLEX / SUPER DUPLEX

660 A, 660 B, UNS 31803, S 32750, S 32760

STAINLESS STEELS

304, 304L, 309, 310, 316, 316L, 317, 317L, 321, 347, 410, 416, 430, 501

ALUMINIUM

Aluminium 2024, Aluminium 6061





WE-LOCK Co.

AN ISO 9001 : 2008 / ISO 14001 / ISO 18001 CERTIFIED COMPANY

Hex Bolts & Hex Screws DIN 931 / ISO4014 & DIN 933/ISO4017

Our range of Hex Bolts & Hex Screws are widely used for high-end industrial purpose and automobile industry. These are acknowledged for wear & tear resistance, cost effectiveness, and long functional life. The Hex Head Bolts offered by us are at par with international quality standards. These are available in various shapes and sizes, and other customized forms as per client's specifications and details. We offer these bolts in various grades to suit the application area at industry Competitive prices.

Stainless Steels Material Grade : 304, 304B, 309, 310, 316, 316B, 317, 317L, 321, 347, 401, 416, 430 & 501.

Diameter : M27 to M52 up to 500 MM in Length

Duplex & Super Duplex : UNS31803,S32750.

Diameter : M16 to M42 up to 300 MM in Length

Hastelloy : Hastelloy C-276, Hastelloy C-22.

Diameter : M8 to M27 up to 300 MM in Length

Exotics : 904L, A-286, Alloy20, Alloy50, NitronicAlloys50, Titanium.

Diameter : M8 to M27 up to 300 MM in Length

Nickel Alloys : Inconel600,601,625,718,750,800/800H,825,925,Monel 400,405,K-500 & Nickel 200.

Diameter : M8 to M27 up to 300 MM in Length

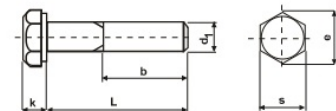

"b" measurement varies according to length of bolt

* All measurement in millimeters (mm)*
DIN 931/ISO 4014

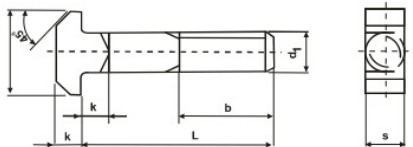

* All measurement in millimeters (mm)*
DIN 186

T- Head Bolts

These bolts are fabricated in compliance with international quality standards. Our range of T-Head Bolts is quality tested on various parameters to ensure defect free assortment reaches at client's end. T-Head Bolts offered by us are widely used in various sectors such as refineries, petrochemicals, pesticides, fertilizers and many more. These are highly acknowledged for their salient features such as accurate construction, heat and moisture resistance, efficient performance and long functional life. Our range of T-Head Bolts is precision engineered in T-head shapes, and is available in custom made specifications as per customer's requirements.

Stainless Steels Material Grade : 304, 304B, 309, 310, 316, 316B, 317, 317L, 321, 347, 401, 416, 430 & 501.

Diameter : M16 to M42 up to 300 MM in Length

Exotic : 904L, A-286, Alloy20, Alloy 50, Nitronic Alloy 50, Titanium

Diameter : M16 to M42 up to 300 MM in Length



WE-LOCK CO.

AN ISO 9001 : 2008 / ISO 14001 / ISO 18001 CERTIFIED COMPANY

STONE CALDDING CLAMPS

Marble Fixing System

Stainless Steels Material Grade : 304 & 316



Sleeve Anchor

Product Detail

we are produce the stainless steel anchor, wedge anchor, sleeve anchor, bolt anchor and so on,

Stainless Steel Material Grade : is s.s 304, s.s 316

Wedge Anchor

Stainless Steels Material Grade : 304 & 316





WE-LOCK CO.

AN ISO 9001 : 2008 / ISO 14001 / ISO 18001 CERTIFIED COMPANY

Hexagonal Nut

Hexagon Nuts are Designed to perfection, these nuts possess close tolerance and precision dimensions. Our quality controllers undertake stringent quality measures in order to provide our clients a flawless range of nuts. Further, to retain the trust of our valued clients, we also provide them with certificate regarding testing parameters undertaken by our organization. We offer our range of Hexagon Nuts in various sizes, thicknesses & dimensions, and material grades. These nuts meet the requirements of hardware, engineering, electrical and various other industries. We also customize our range of Hexagonal Nuts to meet the different requirements of our clients. Further, our range can be availed at market competitive prices.



Stainless Steels Material Grade : 304, 304B, 309, 310, 316, 316B, 317, 317L, 321, 347, 401, 416, 430 & 501.

Diameter : M27 to M52

Duplex & Super Duplex : UNS 31803, S 32750.

Diameter : M16 to M52

Hastelloy : Hastelloy C-276, Hastelloy C-22.

Diameter : M8 to M27

Exotics : 904L, A-286, Alloy 20, Alloy 50, Nitronic Alloys 50, Titanium.

Diameter : M8 to M27

Nickel Alloys : Inconel 600, 601, 625, 718, 750, 800/800H, 825, 925, Monel 400,405,K-500 & Nickel 200.

Diameter : M8 to M27

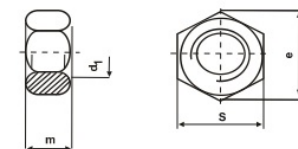

* All measurement in millimeters (mm)*

DIN 934 / ISO 4032

Hexagon Domed Cap Nuts



Our range is widely used in wheels, steering columns and body exposed parts.

These are appreciated for excellent durability, high temperature resistance and capability to withstand chemicals. We offer our range of Hexagon Nuts in various shapes, sizes, dimensions, and grades. Moreover, with the assistance of our team of professionals, we are able to meet the various requirements of clients. To provide these nuts in appropriate condition to our clients, we package these nuts using quality packaging material.



WE-LOCK Co.

AN ISO 9001 : 2008 / ISO 14001 / ISO 18001 CERTIFIED COMPANY

U-Bolts Standard

We are able to provide extensive range of U-Bolts. The precision engineered range of U-Bolts offered by us are at par with international quality standards and available in various grades, sizes, thicknesses, and dimensions as per the industry related application. Besides, we also offer these U-Bolts with extra long nuts and in full round, half round and square profiles on client's request.

Stainless Steels Material Grade : 304, 304B, 309, 310, 316, 316B, 317, 317L, 321, 347, 401, 416, 430 & 501.

Diameter : M6 to M36

Duplex & Super Duplex : UNS31803, S32750.

Diameter : M6 to M36

Hastelloy : Hastelloy C-276, Hastelloy C-22.

Diameter : M6 to M20

Exotics : 904L, A-286, Alloy20, Alloy50, NitronicAlloys50, Titanium.

Diameter : M6 to M20

Nickel Alloys : Inconel600,601,625,718,750,800/800H,825,925,Monel400,405,K-500 & Nickel 200.

Diameter : M6 to M20

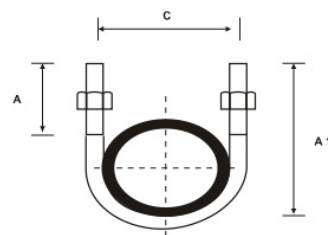

Features :

- Accurate dimension
- Corrosion resistance
- High efficiency
- High tensile strength Durability

Application Area :

- Pipe clamping
- Foundation support
- Installations and automotive support systems

Foundation Bolts

We are engaged in providing a precision engineered range of Foundation Bolts to our clients based across the globe. These bolts are manufactured using high quality raw material and as per the latest technical developments. We offer our range of Foundation Bolts in various sizes, thicknesses, lengths, and material. These are extensively used in numerous industrial sectors. Our wide assortment of Foundation Bolts is highly appreciated for its excellent tensile strength, durability, and dimensional accuracy. These corrosion resistance bolts are in high demand among our clients spread in different parts of the world. We are successful in catering to the diverse requirements of our clients as we also offer customization facility. Moreover our range of Foundation Bolts is available at market competitive prices.

RANGE : M10 to M100, length upto 5 meters

NICKEL ALLOY

Standard : ASTM / ASME SB 160 / 164 / 425 / 166 / 446 / 574 / 472

Grade : UNS 2200 (NICKEL 200) / UNS 2201 (NICKEL 201), UNS 4400 (MONEL 400), UNS 8825 (INCONEL 825), UNS 6600 (INCONEL 600) / UNS 6601 (INCONEL 601), UNS 6625 (INCONEL 625), UNS 10276 (HASTELLOY C 276), UNS 8020 (ALLOY 20 / 20 CB 3)

STAINLESS STEEL

Standard : ASTM / ASME A/SA 193 / 194

Grade : B 8 (304), B 8C (SS 347), B 8M (SS 316), B 8 T (SS 321), A 2, A 4

ALLOY STEEL

Standard : ASTM / ASME A/SA 193 / 194 Gr.

Grade : B 6, B 7 / B 7M, B 16, 2, 2HM, 2H, GR 6, B 7, B 7M.

Duplex Steel : UNS No.S 31803, S 32205

- Coating
- Hot Dipped Galvanizing
- Phosphate
- Teflon
- Xylon
- Zinc
- Cadmium

Test Certificate : manufacturer test certificate as per en 10204 / 3.1b





WE-LOCK Co.

AN ISO 9001 : 2008 / ISO 14001 / ISO 18001 CERTIFIED COMPANY

DEVELOPING TOMORROW'S TODAY

Hexagon Thin Nuts

We manufacture a comprehensive range of Hexagon Thin Nut. These nuts are fabricated using high-grade stainless steel, nickel alloy, and other useful material in compliance with International quality standards. The Hexagonal Thin Nuts offered by us are appreciated for stiffness, hardness, durability, and ability to withstand harsh weather conditions. Reliable and rust proof nuts are available in various sizes, lengths, thicknesses, dimensions and grades, which can be further custom made as required by our clients. Our range of Hexagon Thin Nut is widely used in heavy duty applications and various other industrial purposes.



Stainless Steels Material Grade : 304, 304B, 309, 310, 316, 316B, 317, 317L, 321, 347, 401, 416, 430 & 501.

Diameter : M27 to M52

Duplex & Super Duplex : UNS31803,S32750.

Diameter : M16 to M52

Hastelloy : Hastelloy C-276, Hastelloy C-22.

Diameter : M8 to M27

Exotics : 904L, A-286, Alloy20, Alloy50, NitronicAlloys50, Titanium.

Diameter : M8 to M27

Nickel Alloys : Inconel600,601,625,718,750,800/800H,825,925,Monel 400,405,K-500 & Nickel 200.

Diameter : M8 to M27

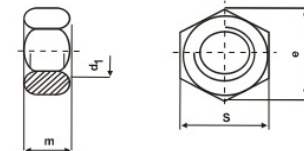

* All measurement in millimeters (mm)*

DIN 439 / ISO 4035

Threaded Rods: DIN 975 & DIN 976

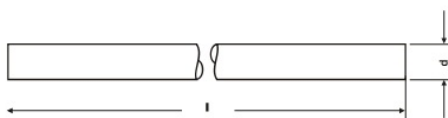

Stainless Steels Material Grade : 304, 304B, 309, 310, 316, 316B, 317, 317L, 321, 347, 401, 416, 430 & 501.

Diameter : M3 to M70 From 10MM to 3000MM

Duplex & Super Duplex:UNS31803,S32750.

Diameter : M3 to M70 From 10MM to 1000MM

Hastelloy : Hastelloy C-276, Hastelloy C-22.

Diameter : M3 to M36 From 10MM to 1000MM

Exotics : 904L, A-286, Alloy20, Alloy50, NitronicAlloys50, Titanium.

Diameter : M3 to M36 From 10MM to 1000MM

Nickel Alloys : Inconel600, 601, 625, 718, 750, 800/800H, 825,925, Monel 400, 405, K-500 & Nickel 200.

Diameter : M3 to M36 From 10MM to 1000MM



WE-LOCK CO.

AN ISO 9001 : 2008 / ISO 14001 / ISO 18001 CERTIFIED COMPANY

Refractory Anchor

SS **Refractory Anchors** are manufactured from good grades of steel and have find applications in various industries. Some of the industries are cement, ceramic, steel, thermal, petrochemical, power and many more. The Stainless Steel Refractory Anchors offered by us are available in assortment of shapes and sizes but usually they are in the shape of Y, U and V. In addition to this, we provide availability of Refractory Anchors in unlike specifications as per the preferences of global clients. We are tagged as one of the most illustrious Industrial Refractory Anchors Suppliers from India. To enquire about the desired product(s)

Chemical Composition of Stainless Sreel

Chemical Composition Per Cent/ Grade	C % Max	Mn % Max	P % Max	S % Max	Si % Max	Cr %	Ni% Max	Nr% Max
304 304-L	0.08 0.03	2.00	0.045	0.030	1.00 0.75	18.00 to 20.00		08.00 to 10.00
310 310S	0.25 0.08	2.00	0.045	0.030	1.00 0.75	24.00 to 26.00		19.00 to 22.00

Temperature Resistant of Anchor Metal

Anchor Metal	Temperature Resistant
Mild Steel [MS]	540 Degree C
Stainless Steel 304	1080 Degree C
Stainless Steel 310	1350 Degree C

Spiral-Y-Anchors >>

We are specialized in manufacturing superior quality Spiral Y- Anchors, these are widely used in various industrial applications.

Specifications

- 215 X 145 X 5 MM
- 190 X 45 X 5 MM.
- 185 X 105 X 5 MM.
- 175 X 30 X 5 MM.
- 155 X 70 X 5 MM.
- 90 X 30 X 5 MM.
- 80 X 30 X 5 MM.



U-Anchors >>

We manufacture and export superior quality U-Anchors, these can be availed in various specifications like:

- 55 X 16 X 05 MM.
- 225 X 27 X 05 MM.
- Wing Nut Type



V-Anchors >>

We are manufacturer & supplier of V-Anchor, to match all types of lining for cement, ceramic, steel, petrochemical, refinery industry for the retaining of monolithic, ceramic fiber and brick linings. Our anchors are suitable for single & dual layer lining, brick, ceramic, fiber and monolithic. All refractory anchor made from stainless steel [SS] 304, 310, Alloy 601- inonel and other heat resistant alloys.



Specifications:

- 55 X 15 X 05 MM

Y-Anchors and Crook Anchors >>

We manufacture a comprehensive range of refractory anchors for the cement, steel and petrochemical industry - for the retaining of castable and brick linings. Y Anchors and Crook Anchors are offered for immediate dispatch. Various C Clips and Hangers for ceramic anchors to suit individual requirements.

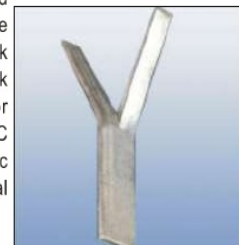

Specifications

- 230 X 115 X 05 MM.
- 200 X 100 X 05 MM.
- 150 X 75 X 05 MM.
- 75 X 25 X 05 MM.



WE-LOCK CO.

AN ISO 9001 : 2008 / ISO 14001 / ISO 18001 CERTIFIED COMPANY

Hexagon Socket Set Screws With Dog Point

Stainless Steels Material Grade : 304, 304B, 309, 310, 316, 316B, 317, 317L, 321, 347, 401, 416, 430 & 501.

Diameter : M6 to M27 up to 200 MM in Length

Duplex & Super Duplex : UNS31803, S32750.

Diameter : M6 to M27 up to 100 MM in Length

Hastelloy : Hastelloy C-276, Hastelloy C-22.

Diameter : M6 to M27 up to 100 MM in Length

Exotics : 904L, A-286, Alloy20, Alloy50, NitronicAlloys50, Titanium.

Diameter : M6 to M27 up to 100 MM in Length

Nickel Alloys : Inconel600, 601, 625, 718, 750, 800/800H, 825, 925, Monel 400, 405, K-500 & Nickel 200.

Diameter : M6 to M27 up to 100 MM in Length

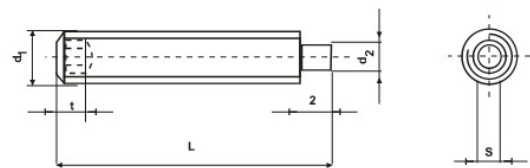

* All measurement in millimeters (mm)*

DIN 915 / ISO 4028

Hexagon Socket Set Screws With Cup Point

Stainless Steels Material Grade : 304, 304B, 309, 310, 316, 316B, 317, 317L, 321, 347, 401, 416, 430 & 501.

Diameter : M6 to M27 up to 200 MM in Length

Duplex & Super Duplex : UNS31803, S32750.

Diameter : M6 to M27 up to 100 MM in Length

Hastelloy : Hastelloy C-276, Hastelloy C-22.

Diameter : M6 to M27 up to 100 MM in Length

Exotics : 904L, A-286, Alloy20, Alloy50, NitronicAlloys50, Titanium.

Diameter : M6 to M27 up to 100 MM in Length

Nickel Alloys : Inconel600, 601, 625, 718, 750, 800/800H, 825, 925, Monel 400, 405, K-500 & Nickel 200.

Diameter : M6 to M27 up to 100 MM in Length

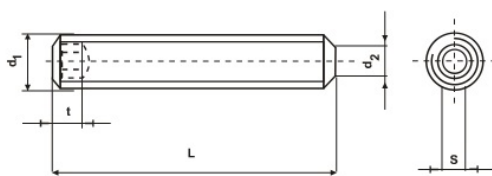

* All measurement in millimeters (mm)*

DIN 916 / ISO 4029



WE-LOCK Co

AN ISO 9001 : 2008 / ISO 14001 / ISO 18001 CERTIFIED COMPANY

Plain Washers

We manufacture range of Plain Washers in different size options, dimensions, and finishes to suit different industrial applications. These are in high demands in the competitive market owing to their dimensional accuracy, high tensile strength, abrasion resistance, flawless finish, and durability. Our range of Plain Washer is quality tested on well defined parameters by our team of quality controllers. We also manufacture different types of washers as well i.e **Tab Washers, Heavy Duty Washers, Tooth Washers**, etc. To satisfy our clients fully, we also provide them with testing certificate. Our plain washers are also available in customized forms and at market competitive price.



Stainless Steels Material Grade : 304, 304B, 309, 310, 316, 316B, 317, 317L, 321, 347, 401, 416, 430 & 501.

Diameter : M6 to M72

Duplex & Super Duplex : UNS31803,S32750.

Diameter : M6 to M72

Hastelloy : Hastelloy C-276, Hastelloy C-22.

Diameter : M6 to M72

Exotics : 904L, A-286, Alloy20, Alloy50, NitronicAlloys50, Titanium.

Diameter : M6 to M72

Nickel Alloys : Inconel600, 601, 625, 718, 750, 800/800H, 825, 925, Monel 400, 405, K-500 & Nickel 200.

Diameter : M6 to M72

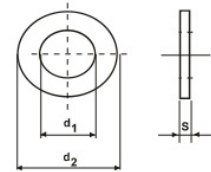

* All measurement in millimeters (mm)*
DIN 125 / DIN 7089

Double End Stud Bolts

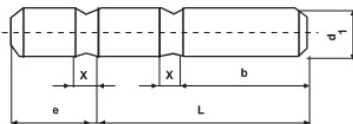

* All measurement in millimeters (mm)*

DIN 835

Stainless Steels Material Grade : 304, 304B, 309, 310, 316, 316B, 317, 317L, 321, 347, 401, 416, 430 & 501.

Diameter : M16 to M30 up to 1000 MM in Length

Duplex & Super Duplex : UNS31803,S32750.

Diameter : M16 to M30 up to 1000 MM in Length

Hastelloy : Hastelloy C-276, Hastelloy C-22.

Diameter: M16 to M30 up to 1000 MM in Length

Exotics : 904L, A-286, Alloy20, Alloy50, NitronicAlloys50, Titanium.

Diameter : M16 to M30 up to 1000 MM in Length

Nickel Alloys : Inconel600,601,625,718,750,800/800H,825,925,Monel 400,405,K-500 & Nickel 200.

Diameter : M16 to M30 up to 1000 MM in Length



WE-LOCK CO.

AN ISO 9001 : 2008 / ISO 14001 / ISO 18001 CERTIFIED COMPANY

Socket Head Allen Cap Screws

Stainless Steels Material Grade : 304, 304B, 309, 310, 316, 316B, 317, 317L, 321, 347, 401, 416, 430 & 501.

Diameter : M24 to M36 up to 300 MM in Length

Duplex & Super Duplex : UNS31803, S32750.

Diameter : M8 to M36 up to 300 MM in Length

Hastelloy : Hastelloy C-276, Hastelloy C-22.

Diameter : M8 to M36 up to 300 MM in Length

Exotics : 904L, A-286, Alloy20, Alloy50, NitronicAlloys50, Titanium.

Diameter : M8 to M36 up to 300 MM in Length

Nickel Alloys : Inconel600, 601, 625, 718, 750, 800/800H, 825, 925,

Monel 400, 405, K-500 & Nickel 200.

Diameter : M8 to M36 up to 300 MM in Length

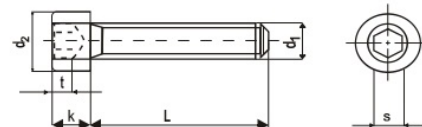

* All measurement in millimeters (mm)*
DIN 912 / DIN 4762



Socket Head Cap Screws Low Head

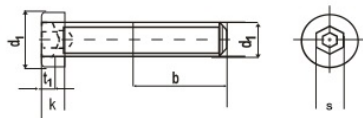
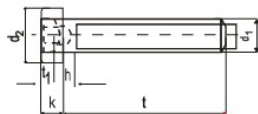

* All measurement in millimeters (mm)*
DIN 6912

Stainless Steels Material Grade : 304, 304B, 309, 310, 316, 316B, 317, 317L, 321, 347, 401, 416, 430 & 501.

Diameter: M16 to M27 up to 200 MM in Length



WE-LOCK CO.

AN ISO 9001 : 2008 / ISO 14001 / ISO 18001 CERTIFIED COMPANY

DEVELOPING TOMORROW'S TODAY

Hexagon Socket Set Screws With Flat Point

Stainless Steels Material Grade : 304, 304B, 309, 310, 316, 316B, 317, 317L, 321, 347, 401, 416, 430 & 501.

Diameter : M6 to M27 up to 200 MM in Length

Duplex & Super Duplex : UNS31803,S32750.

Diameter : M6 to M27 up to 100 MM in Length

Hastelloy : Hastelloy C-276, Hastelloy C-22.

Diameter : M6 to M27 up to 100 MM in Length

Exotics : 904L, A-286, Alloy20, Alloy50, NitronicAlloys50, Titanium.

Diameter : M6 to M27 up to 100 MM in Length

Nickel Alloys : Inconel600, 601, 625, 718, 750, 800/800H, 825, 925,

Monel 400, 405, K-500 & Nickel 200.

Diameter : M6 to M27 up to 100 MM in Length

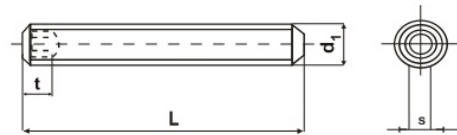

* All measurement in millimeters (mm)*

DIN 913 / DIN 4026

Hexagon Socket Set Screws With Cone Point

Stainless Steels Material Grade : 304, 304B, 309, 310, 316, 316B, 317, 317L, 321, 347, 401, 416, 430 & 501.

Diameter : M6 to M27 up to 200 MM in Length

Duplex & Super Duplex : UNS31803,S32750.

Diameter : M6 to M27 up to 100 MM in Length

Hastelloy : Hastelloy C-276, Hastelloy C-22.

Diameter : M6 to M27 up to 100 MM in Length

Exotics : 904L, A-286, Alloy20, Alloy50, NitronicAlloys50, Titanium.

Diameter : M6 to M27 up to 100 MM in Length

Nickel Alloys : Inconel600, 601, 625, 718, 750, 800/800H, 825, 925,

Monel 400, 405, K-500 & Nickel 200.

Diameter : M6 to M27 up to 100 MM in Length

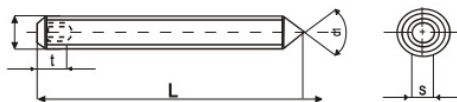

* All measurement in millimeters (mm)*

DIN 914 / DIN 4027

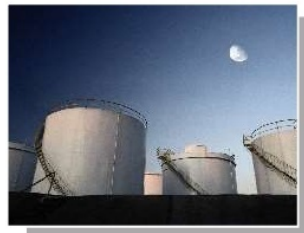

DEVELOPING TOMORROW'S TODAY

WE-LOCK CO.

AN ISO 9001 : 2008 / ISO 14001 / ISO 18001 CERTIFIED COMPANY

REG OFFICE:- 184/186 MINARA MANSION, SVP ROAD, NEAR ROUND TEMPLE, MUMBAI
400004, MAHARASHTRA, INDIA.

WORKS: Plot 2808, G.I.D.C, UMERGAON DIST: VALSAD , GUJRAT, INDIA

Tel: +91 22 2389 1628

Fax: +91 22 2389 1628

Mob: +91 8484 90 2820 / 91 950 117 8117

Email: sales@we-lock.in

Web: www.we-lock.in

MANUFACTURER, EXPORTER OF BOLT, STUDS, NUT, THREADED BARS WITH QAP & MTC.